



Network Traffic Camera

Quick Start Guide

Quick Start Guide

©2018 Hangzhou Hikvision Digital Technology Co., Ltd.

This manual is intended for users of 91xx Series Network Traffic Camera. It includes instructions on how to use the Product. The software embodied in the Product is governed by the user license agreement covering that Product.

About this Manual

This Manual is subject to domestic and international copyright protection. Hangzhou Hikvision Digital Technology Co.,S Ltd. (“Hikvision”) reserves all rights to this manual. This manual cannot be reproduced, changed, translated, or distributed, partially or wholly, by any means, without the prior written permission of Hikvision.

Trademarks

HIKVISION and other Hikvision marks are the property of Hikvision and are registered trademarks or the subject of applications for the same by Hikvision and/or its affiliates. Other trademarks mentioned in this manual are the properties of their respective owners. No right of license is given to use such trademarks without express permission.

Disclaimer

TO THE MAXIMUM EXTENT PERMITTED BY APPLICABLE LAW, HIKVISION MAKES NO WARRANTIES, EXPRESS OR IMPLIED, INCLUDING WITHOUT LIMITATION THE IMPLIED WARRANTIES OF MERCHANTABILITY AND FITNESS FOR A PARTICULAR PURPOSE, REGARDING THIS MANUAL. HIKVISION DOES NOT WARRANT, GUARANTEE, OR MAKE ANY REPRESENTATIONS REGARDING THE

USE OF THE MANUAL, OR THE CORRECTNESS, ACCURACY, OR RELIABILITY OF INFORMATION CONTAINED HEREIN. YOUR USE OF THIS MANUAL AND ANY RELIANCE ON THIS MANUAL SHALL BE WHOLLY AT YOUR OWN RISK AND RESPONSIBILITY.

TO THE MAXIMUM EXTENT PERMITTED BY APPLICABLE LAW, IN NO EVENT WILL HIKVISION, ITS DIRECTORS, OFFICERS, EMPLOYEES, OR AGENTS BE LIABLE TO YOU FOR ANY SPECIAL, CONSEQUENTIAL, INCIDENTAL, OR INDIRECT DAMAGES, INCLUDING, AMONG OTHERS, DAMAGES FOR LOSS OF BUSINESS PROFITS, BUSINESS INTERRUPTION, SECURITY BREACHES, OR LOSS OF DATA OR DOCUMENTATION, IN CONNECTION WITH THE USE OF OR RELIANCE ON THIS MANUAL, EVEN IF HIKVISION HAS BEEN ADVISED OF THE POSSIBILITY OF SUCH DAMAGES.

SOME JURISDICTIONS DO NOT ALLOW THE EXCLUSION OR LIMITATION OF LIABILITY OR CERTAIN DAMAGES, SO SOME OR ALL OF THE ABOVE EXCLUSIONS OR LIMITATIONS MAY NOT APPLY TO YOU.

Privacy Notice

Surveillance laws vary by jurisdiction. Check all relevant laws in your jurisdiction before using this product for surveillance purposes to ensure that your use of this product conforms.

Support

Should you have any questions, please do not hesitate to contact your local dealer.

0503001080509

Regulatory Information

FCC Information

FCC compliance: This equipment has been tested and found to comply with the limits for a Class B digital device, pursuant to part 15 of the FCC Rules. These limits are designed to provide reasonable protection against harmful interference in a residential installation. This equipment generates, uses and can radiate radio frequency energy and, if not installed and used in accordance with the instructions, may cause harmful interference to radio communications. However, there is no guarantee that interference will not occur in a particular installation. If this equipment does cause harmful interference to radio or television reception, which can be determined by turning the equipment off and on, the user is encouraged to try to correct the interference by one or more of the following measures:

- Reorient or relocate the receiving antenna.
- Increase the separation between the equipment and receiver.
- Connect the equipment into an outlet on a circuit different from that to which the receiver is connected.
- Consult the dealer or an experienced radio/TV technician for help

FCC Conditions

This device complies with part 15 of the FCC Rules. Operation is subject to the following two conditions:

1. This device may not cause harmful interference.
2. This device must accept any interference received, including interference that may cause undesired operation.

EU Conformity Statement



This product and - if applicable - the supplied accessories too are marked with "CE" and comply therefore with the applicable harmonized European standards listed under the EMC Directive 2014/30/EU, the RoHS Directive 2011/65/EU.



2012/19/EU (WEEE directive): Products marked with this symbol cannot be disposed of as unsorted municipal waste in the European Union. For proper recycling, return this product to your local supplier upon the purchase of equivalent new equipment, or dispose of it at designated collection points. For more information see: www.recyclethis.info



2006/66/EC (battery directive): This product contains a battery that cannot be disposed of as unsorted municipal waste in the European Union. See the product documentation for specific battery information. The battery is marked with this symbol, which may include lettering to indicate cadmium (Cd), lead (Pb), or mercury (Hg). For proper recycling, return the battery to your supplier or to a designated collection point. For more information see: www.recyclethis.info



Safety Instruction

These instructions are intended to ensure that user can use the product correctly to avoid danger or property loss.

The precaution measure is divided into “Warnings” and “Cautions”

Warnings: Serious injury or death may occur if any of the warnings are neglected.

Cautions: Injury or equipment damage may occur if any of the cautions are neglected.

	
<p>Warnings Follow these safeguards to prevent serious injury or death.</p>	<p>Cautions Follow these precautions to prevent potential injury or material damage.</p>



Warnings

- In the use of the product, you must be in strict compliance with the electrical safety regulations of the nation and region. Please refer to technical specifications for detailed information.
- Input voltage should meet both the SELV (Safety Extra Low Voltage) and the Limited Power Source with 24 VDC according to the IEC60950-1 standard. Please refer to technical specifications for detailed information.

Network Traffic Camera ▪ Quick Start Guide

- Do not connect several devices to one power adapter as adapter overload may cause over-heating or a fire hazard.
- Please make sure that the plug is firmly connected to the power socket. When the product is mounted on wall or ceiling, the device shall be firmly fixed.
- If smoke, odor or noise rise from the device, turn off the power at once and unplug the power cable, and then please contact the service center.



Cautions

- Make sure the power supply voltage is correct before using the camera.
- Do not drop the camera or subject it to physical shock.
- Do not touch sensor modules with fingers. If cleaning is necessary, use clean cloth with a bit of ethanol and wipe it gently. If the camera will not be used for an extended period, please replace the lens cap to protect the sensor from dirt.
- Do not aim the camera at the sun or extra bright places. Blooming or smearing may occur otherwise (which is not a malfunction), and affect the endurance of sensor at the same time.
- The sensor may be burned out by a laser beam, so when any laser equipment is in using, make sure that the surface of sensor will not be exposed to the laser beam.

Network Traffic Camera ▪ Quick Start Guide

- Do not place the camera in extremely hot, cold (the operating temperature shall be between $-30^{\circ}\text{C} \sim 70^{\circ}\text{C}$), dusty or damp locations, and do not expose it to high electromagnetic radiation.
- To avoid heat accumulation, good ventilation is required for operating environment.
- Keep the camera away from liquid while in use.
- While in delivery, the camera shall be packed in its original packing, or packing of the same texture.
- Regular part replacement: a few parts (e.g. electrolytic capacitor) of the equipment shall be replaced regularly according to their average enduring time. The average time varies because of differences between operating environment and using history, so regular checking is recommended for all the users. Please contact with your dealer for more details.
- Improper use or replacement of the battery may result in hazard of explosion. Replace with the same or equivalent type only. Dispose of used batteries according to the instructions provided by the battery manufacturer.
- If the product does not work properly, please contact your dealer or the nearest service center. Never attempt to disassemble the camera yourself. (We shall not assume any responsibility for problems caused by unauthorized repair or maintenance.)

Table of Contents

1 Appearance Description	9
1.1 Type I Camera Overview	9
1.1.1 Side Panel Overview	9
1.1.2 Rear Panel Overview	11
1.2 Type II Camera Overview	15
2 Installation	17
2.1 Type I Camera Installation	17
2.2 Type II Camera Installation	22
2.2.1 Memory Card Installation	22
2.2.2 Wall/Ceiling Mounting	25
2.2.3 Pole Mounting	27
3 Setting the Network Camera over the LAN	33
3.1 Activating the Camera	33
3.1.1 Activation via Web Browser	33
3.1.2 Activation via SADP Software	35
3.2 Modifying the IP Address	36
4 Accessing via Web Browser	38

1 Appearance Description

The camera series has two appearance types:

1.1 Type I Camera Overview

1.1.1 Side Panel Overview

The side panel of the box camera is shown below:

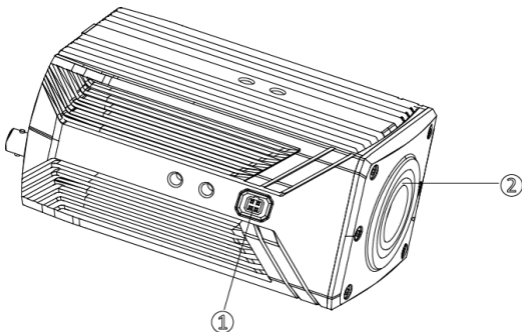

Figure 1-1 Overview

Table 1-1 Description

Network Traffic Camera • Quick Start Guide

No.	Description	No.	Description
1	Auto-iris Lens Socket	2	Lens Interface

The type of auto-iris lens socket interface is shown below:

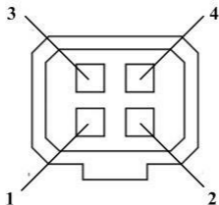

Figure 1-2 Auto-iris Interface

Table 1-2 Pins

No.	DC-driven
1	Damp-
2	Damp+
3	Drive+
4	Drive-

Damp+, Damp-, Drive+ and Drive- pins are used when the auto-iris is driven by DC.

1.1.2 Rear Panel Overview

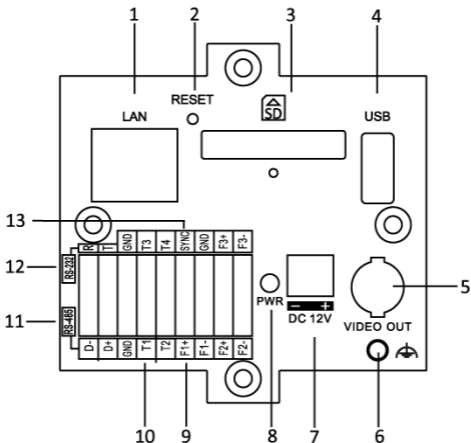

Table 1-3 Overview of Type I Rear Panel

Table 1-4 Description of Type I Rear Panel

No.	Description
1	10M/100M/1000M self-adaptive Ethernet interface

Network Traffic Camera ▪ Quick Start Guide

No.	Description
2	Reset
3	SD Card Slot
4	USB 2.0 Interface
5	Video Out/HD-SDI
6	GND
7	Power Supply
8	PWR: Power Indicator
9	F1+, F1-, F2+, F2-, F3+, F3-: Alarm Out (F1, F2 support strobe light connection)
10	T1, T2, T3, T4: Alarm In
11	RS-485 Interface
12	RS-232 Interface
13	SYNC Interface

Network Traffic Camera • Quick Start Guide

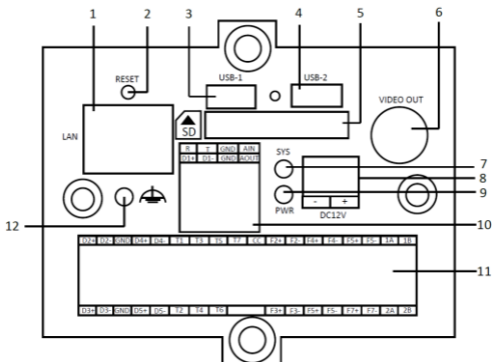

Figure 1-3 Overview of Type II Rear Panel

Table 1-5 Description of Type II Rear Panel

No.	Description
1	10M/100M/1000M Self-adaptive Ethernet Interface
2	RESET: (Reserved)
3	USB 2.0
4	USB 2.0
5	SD Card Slot
6	VIDEO OUT: Analog video output, CVBS/SDI interfaces

Network Traffic Camera ▪ Quick Start Guide

No.	Description
7	System Indicator
8	12V DC Interface
9	PWR: Power Indicator
10	D1: RS-485, RS232, Audio Input and Output
11	D2, D3, D4, D5: RS-485 T1, T2, T3, T4, T5, T6, T7: Trigger interface/SYNC Input F1+, F1-, F2+, F2-, F3+, F3-, F4+, F4-, F5+, F5-, F6+, F6-, F7+, F7-: Flashlight Trigger Output 1A, 1B\2A, 2B: Alarm Output
12	GND



- For some camera models do not support the SD card, and it supports fiber interface to meet the different demands.
- The camera is able to connect to the video out or HD-SDI according to the different connecting camera models.
- SYNC interface connects the external power signal to realize the power synchronization.

1.2 Type II Camera Overview

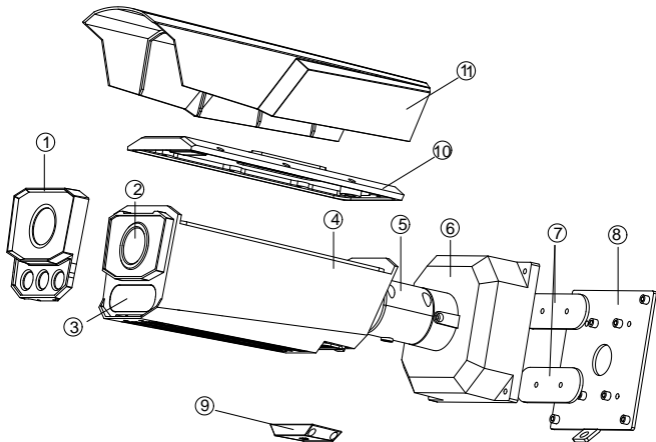

Figure 1-4 Overview of Camera

Table 1-6 Description

No.	Description
1	Front Panel

Network Traffic Camera • Quick Start Guide

No.	Description
2	Lens
3	Supplement Light
4	Main Body
5	Bracket
6	Junction Box
7	Waterproof Screw Jacket
8	Plate
9	Memory Card Cover
10	Top Cover
11	Sunshield

2 Installation

Before you start:

- Make sure the device in the package is in good condition and all the assembly parts are included.
- Make sure all the related equipment is power-off during the installation.
- Check the specification of the products for the installation environment.
- Make sure the power supply is matched with your required voltage to avoid damage.
- If the product does not function properly, please contact your dealer or the nearest service center. Do not disassemble the camera for repair or maintenance by yourself.
- CS type lens is recommended, and you can use the adaptor ring if C type lens is adopted.

2.1 Type I Camera Installation

Housing Installation

Steps:

1. Open the lock catch and take the baseplate out of the housing.



- Two kinds of housings are displayed in the figures below. And we will take type I housing as an example in the following installation steps.

- The housings need to be purchased separately.

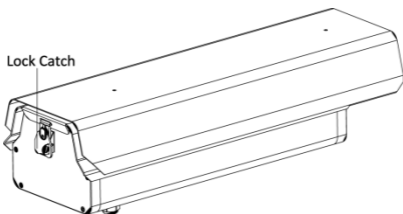

Figure 2-1 Type I Housing

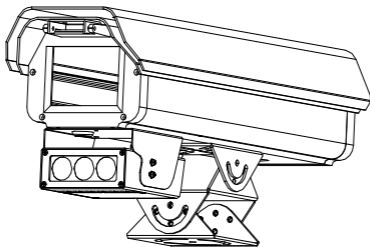

Figure 2-2 Type II Housing

2. Align the camera to the baseplate, and fit the camera to the baseplate with supplied screws.

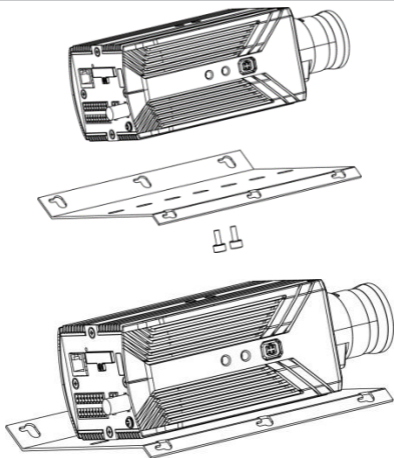

Figure 2-3 Fix the Camera to the Baseplate

3. Place the baseplate with the camera back to the housing.

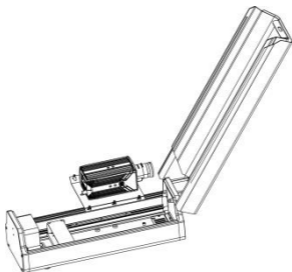

Figure 2-4 Place the Baseplate back to the housing

4. Install the pole mounting hoop to the cross-bar.

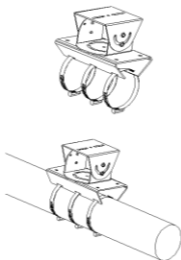

Figure 2-5 Install the Pole Mounting Hoop

5. Install the housing with the camera inside to the hoop.

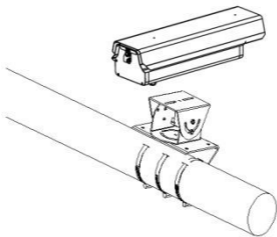

Figure 2-6 Install the Housing

6. Adjust the camera to the desired position, connect the video out to the debug camera, and adjust the zoom and focus of the camera.

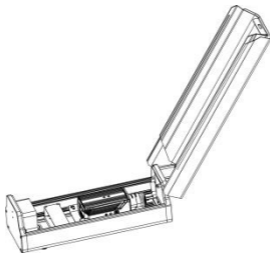

Figure 2-7 Adjust the Camera Position

7. Adjust the pan angle and tilt angle of the camera, place the lid back to the housing, and buckle the lock catch to finish the installation.

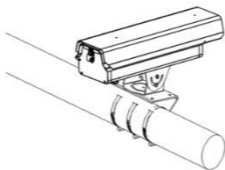

Figure 2-8 Installation Completed

2.2 Type II Camera Installation

2.2.1 Memory Card Installation

Steps:

1. Find memory card cover on camera body.

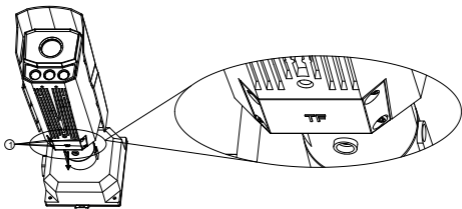

Figure 2-9 Find Memory Card Cover

2. Remove four screws, and move screws and memory card cover.

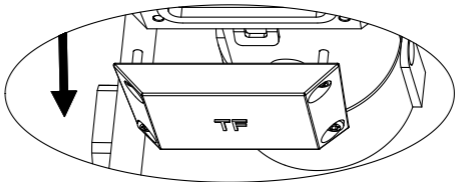

Figure 2-10 Remove screws

3. Insert memory card into slot.

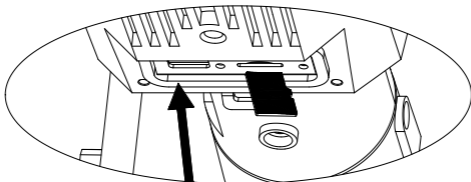

Figure 2-11 Insert Memory Card

4. Install screws and memory card cover.

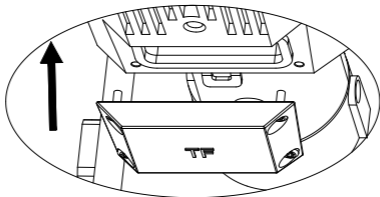

Figure 2-12 Install Screws and Cover

5. Fix memory card cover with four screws.

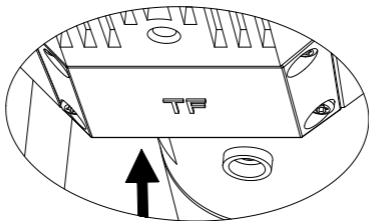

Figure 2-13 Fix Screws

2.2.2 Wall/Ceiling Mounting

Steps:

1. Hook the two ends of the safety rope to the hole on the camera body and the wall (or the ceiling).

Note:

If there is no proper place to secure the safety rope, you can hook the other end of safety rope to the hole at the end of the plate. But you have to make sure that the plate is firm enough to bear/support the weight of the camera.

2. If you need to route cables through the wall (or the ceiling), drill a cable hole in the wall (or the ceiling) according to the plate. Otherwise, skip this step if you want to route the cables through side outlet.
3. Route the cables of the camera.

4. Drill screw holes in the wall or ceiling according to the installation screw hole on the template.
5. Secure the plate to the wall (or the ceiling) with expansion screws.
6. Fix two waterproof screw jackets on the template with supplied screws.
7. Connect cables through the wall or side outlet.
8. Fix the camera to the plate with the supplied screws.

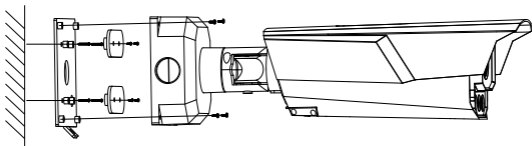

Figure 2-14 Wall Mounting

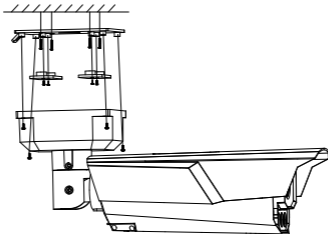

Figure 2-15 Ceiling Mounting

9. Adjust surveillance angel.

- 1) Loosen screw 1 to adjust panning position [0° to 360°]. Tighten the screw.
- 2) Loosen screw 2 to adjust tilting position [0° to 90°]. Tighten the screw.
- 3) Loosen screw 3 to adjust rotating position [0° to 360°]. Tighten the screw.

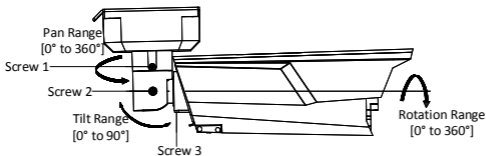

Figure 2-16 3-axis Adjustment

2.2.3 Pole Mounting

Horizontal Pole Mounting

Steps:

1. Route the cables through the cross-bar.
2. Install the pole mounting hoop to the cross-bar.

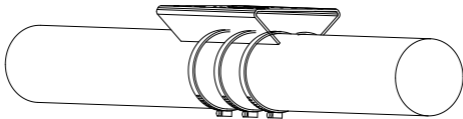

Figure 2-17 Install the Pole Mounting Hoop

3. Install the bottom part of PT-joint to the pole mounting hoop.

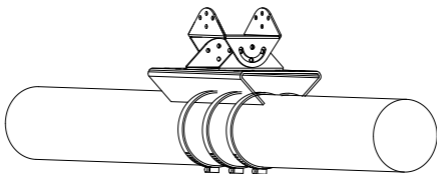

Figure 2-18 Install the Bottom Part of PT-Joint

4. Install the upper part of the PT-joint to the base of camera body.

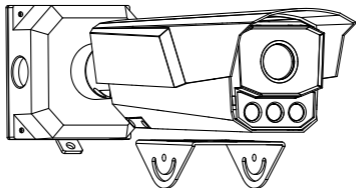

Figure 2-19 Install the Upper Part of PT-Joint

5. Connect two parts of PT-joint.

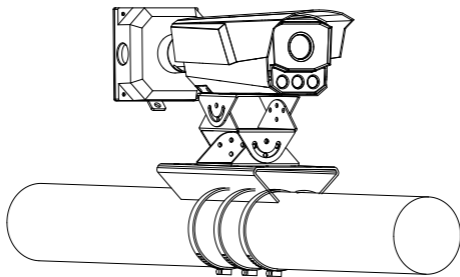

Figure 2-20 Connect Two Parts of PT-Joint

6. Unscrew the plate of the camera and connect cables in the cross-bar and junction box.

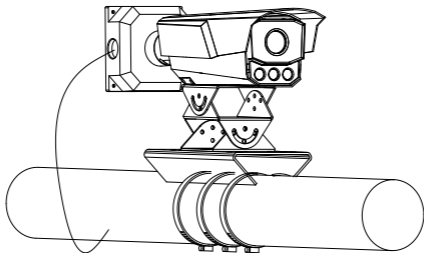

Figure 2-21 Connect Cables

7. Install the plate of the camera.

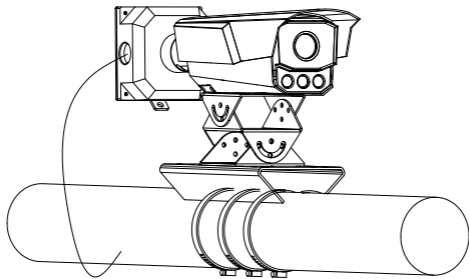

Figure 2-22 Install the Plate

8. Adjust the camera to the desired position, connect the video out to the debug camera, and adjust the zoom and focus of the camera.

Pole Mounting

Steps:

1. Route the cables through the cross-bar.
2. Install the plate to wall and fix waterproof screw jacket to the plate.

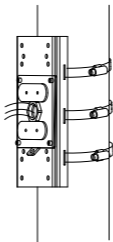

Figure 2-23 Route the cable

3. Connect cables.

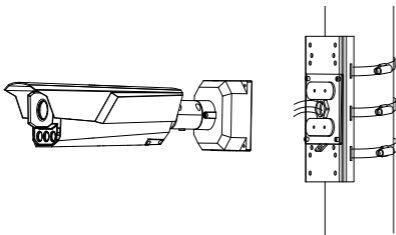

Figure 2-24 Connect cables

4. Secure the bullet camera to the plate with screws.

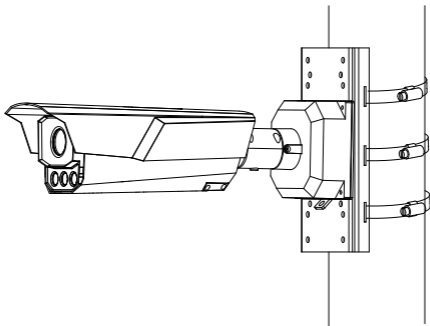

Figure 2-25 Secure the bullet camera

5. Adjust the camera to the desired position, connect the video out to the debug camera, and adjust the zoom and focus of the camera.

3 Setting the Network Camera over the LAN

You are required to activate the camera first by setting a strong password for it before you can use the camera.

Activation via Web Browser, Activation via SADP, and Activation via Client Software are all supported. We will take activation via SADP software and Activation via Web Browser as examples to introduce the camera activation. Please refer to the User Manual of Network Camera for Activation via Client Software.

3.1 Activating the Camera

3.1.1 Activation via Web Browser

Steps:

1. Power on the camera, and connect the camera to the network.
2. Input the IP address into the address bar of the web browser, and click Enter to enter the activation interface.

Notes:

- The default IP address of the camera is 192.168.1.64.
- For the camera enables the DHCP by default, you need to activate the camera via SADP software and search the IP address.



Figure 3-1 Activation Interface(Web)

3. Create a password and input the password into the password field.



STRONG PASSWORD RECOMMENDED– *We highly recommend you create a strong password of your own choosing (using a minimum of 8 characters, including upper case letters, lower case letters, numbers, and special characters) in order to increase the security of your product. And we recommend you reset your password regularly, especially in the high security system, resetting the password monthly or weekly can better protect your product.*

4. Confirm the password.
5. Click **OK** to save the password and enter the live view interface.

3.1.2 Activation via SADP Software

SADP software is used for detecting the online device, activating the camera, and resetting the password.

Get the SADP software from the supplied disk or the official website, and install the SADP according to the prompts. Follow the steps to activate the camera, please refer to the User Manual of Network Camera for other two activation methods.

Steps:

1. Run the SADP software to search the online devices.
2. Check the device status from the device list, and select the inactive device.

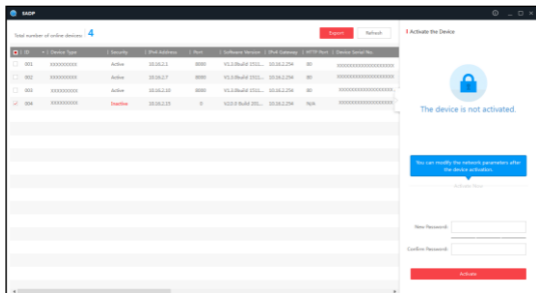

Figure 3-2 SADP Interface

Note:

The SADP software supports activating the camera in batch. Please refer to the user manual of SADP software for details.

3. Create a password and input the password in the password field, and confirm the password.



STRONG PASSWORD RECOMMENDED— *We highly recommend you create a strong password of your own choosing (using a minimum of 8 characters, including upper case letters, lower case letters, numbers, and special characters) in order to increase the security of your product. And we recommend you reset your password regularly, especially in the high security system, resetting the password monthly or weekly can better protect your product.*

4. Click **OK** to save the password.

You can check whether the activation is completed on the popup window. If activation failed, please make sure that the password meets the requirement and try again.

3.2 Modifying the IP Address

Purpose:

To view and configure the camera via LAN (Local Area Network), you need to connect the network camera in the same subnet with your PC. Then, install the SADP software or client software to search and change the IP of network camera. We will take modifying the IP Address via SADP software as an example to introduce the IP address modification.

Steps:

1. Run the SADP software.
2. Select an active device.

Note:

Please refer to Chapter 3.2 to activate the camera if the camera is inactive.

3. Change the device IP address to the same subnet with your computer by either modifying the IP address manually or checking the checkbox of Enable DHCP.

Modify Network Parameters

IP Address:	192.168.1.64
Port:	8000
Subnet Mask:	255.255.255.0
IPv4 Gateway:	192.168.1.1
IPv6 Address:	::
IPv6 Gateway:	::
IPv6 Prefix Length:	0
HTTP Port:	80
Device Serial No.:	XX-XXXXXXX-XXXXXXX

Enable DHCP

Password

Figure 3-3 Modify the IP Address

4. Input the password to activate your IP address modification.
- The batch IP address modification is supported by the SADP; please refer to the User Manual of SADP for details.

4 Accessing via Web Browser

System Requirement:

Operating System: Microsoft Windows XP SP1 and above version

CPU: 2.0 GHz or higher

RAM: 1G or higher

Display: 1024×768 resolution or higher

Web Browser: Internet Explorer 8.0 and above version, Apple Safari 5.0.2 and above version, Mozilla Firefox 5.0 and above version and Google Chrome 18 and above version

Steps:

1. Open the web browser.
2. In the browser address bar, input the IP address of the network camera, and press the **Enter** key to enter the login interface.

Note:

- The default IP address is 192.168.1.64.
 - If the camera is not activated, please activate the camera first according to Chapter 3.2.
3. Input the user name and password.

The admin user should configure the device accounts and user/operator permissions properly. Delete the unnecessary accounts and user/operator permissions.

Note:

The device IP address gets locked if the admin user performs 7 failed password attempts (5 attempts for the user/operator).

4. Click **Login**.

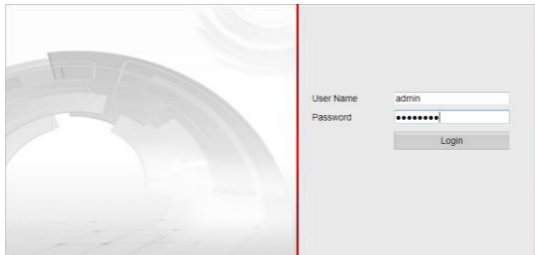

Figure 4-1 Login Interface

5. Install the plug-in before viewing the live video and managing the camera. Please follow the installation prompts to install the plug-in.

Network Traffic Camera ▪ Quick Start Guide

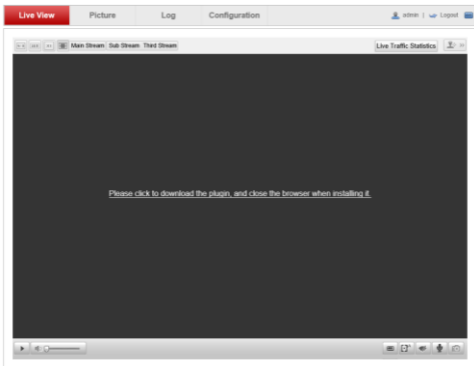

Figure 4-2 Download and Install Plug-in



You may have to close the web browser to finish the installation of the plug-in.

6. Reopen the web browser after the installation of the plug-in and repeat steps 2~4 to login.



For detailed instructions of further configuration, please refer to the user manual of network camera.



See Far, Go Further

UD09691B