

DS-1212ZJ(-S)

Wall Mounting Bracket

Features:

- Die casting aluminum with surface spray treatment
- Design with cable entry hole
- Sponge pat is fixed on the surface of substrate to ensure the stabilization of camera
- The soleplate is rotatable for monitoring scene adjustment

Dimension:

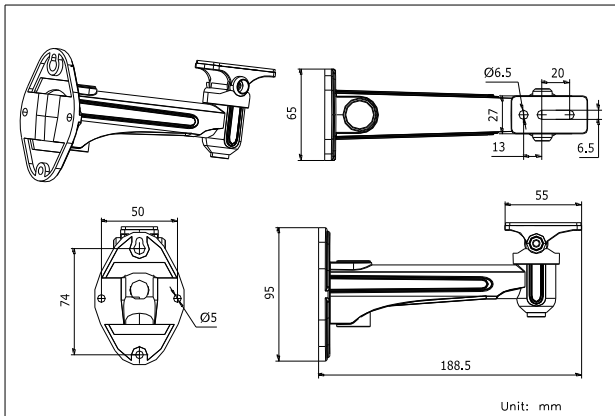

Order model:

DS-1212ZJ

DS-1212ZJ-S

Parameters:

Model	DS-1212ZJ	DS-1212ZJ-S
Parameter	Wall Mounting Bracket	
Color	Hik white	Silver
Feature	Suitable for box, bullet and zoom camera wall mounting	
Material	Aluminum alloy	
Angle	Horizontal:360°; Vertical:-45°~45°	
Dimension	65×95×188.5mm	
Weight	360g	
Configurable Bracket	DS-1275ZJ (vertical pole mount)	

Notice:

- Pay attention to the color matching as selecting bracket
- The bracket is installed on the flat surface of a wall
- The diameter of hole site is within 6.5mm
- The distance between two screw hole is 13~33mm
- The wall must be capable of supporting more than 3 times the total load of the camera and the mount.
- The Max. capacity load of bracket arm is 8.5kg
- The maximum load capacity of the mount is 2.5KG

Installation step:

① Choose the appropriate wall to mount the bracket

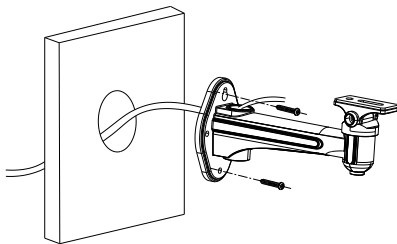

② Complete the fixation and wiring

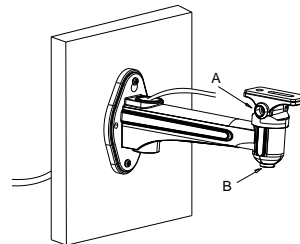

A: Screw of vertical adjust; B: Screw of Horizontal adjust

③ Unscrew the vertical adjusting screw and get the soleplate out of the camera.

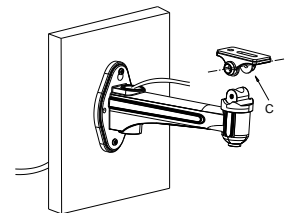

C: Installation base of camera

④ Fix the camera onto the base and screw up

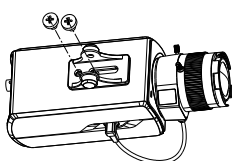

⑤ Fix the IPC & base onto the bracket and screw up

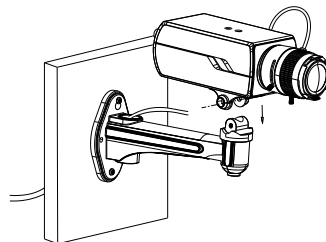

⑥ Wiring and adjust the site and angle of IPC

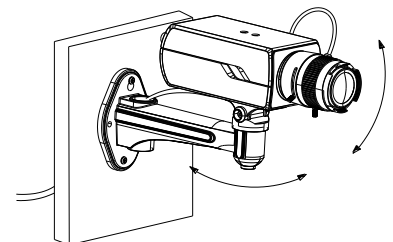

Note: The actual bracket may vary from the picture above.