

DS-1277ZJ

Wall mount for DS-2CD72XX series (with wire intake box)



Features:

- Aluminum alloy material with surface spray treatment
- Beautiful design with wire outlet hole
- Lower weather hidden trouble with gooseneck design
- Special bracket for DS-2CD72XX series
- Waterproof design with wire intake box

Dimension:

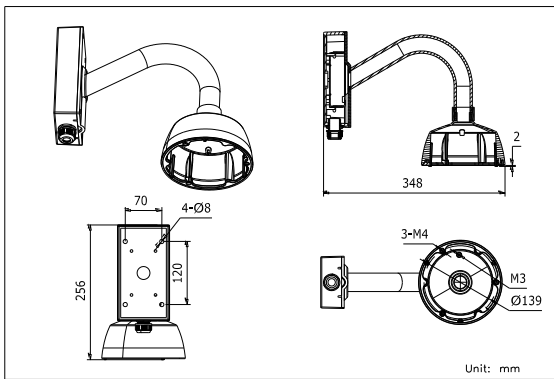

Order model:

DS-1277ZJ

Parameters:

Model	DS-1277ZJ
Parameters	Wall mount for DS-2CD72XX series (with wire intake box)
Color	Hik white
Feature	Suitable for DS-2CD72XX series dome cameras
Material	Aluminum alloy
Dimension	139×256×348mm
Weight	1300g

Notice:

- This bracket is only available for DS-2CD72XX series dome cameras
- Pay attention to the color matching when select bracket
- The bracket should be installed on flat wall
- The wall must be capable of supporting more than 3 times the total load of the camera and the mount.
- The maximum load capacity of the mount is 4.5KG

Installation steps:

- ① Select suitable wall to install wire intake box
- ② Fix the cable across the waterproof plug
- ③ Fix the gooseneck on the wire intake box, wiring and tighten the lock screw
- ④ Screw the bowl on the gooseneck, thread and tighten the lock screw

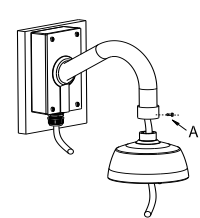
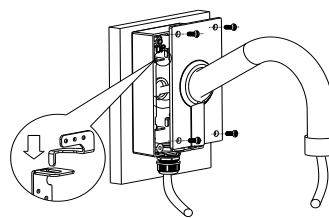
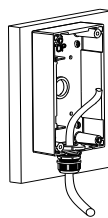
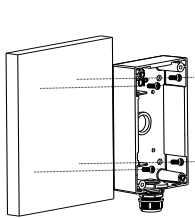

Notice: "A" stands for the lock screw

- ⑤ Open the dome housing, loosen the then take down the dome core
- ⑥ Finish wiring of camera, fix the dome core over the bowl and wiring
- ⑦ Adjust camera angle, install the dome housing and tighten the the lock screw
- ⑧ Finish installation

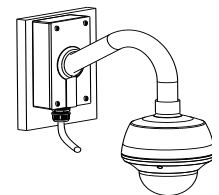
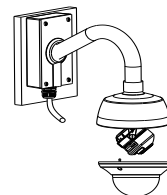
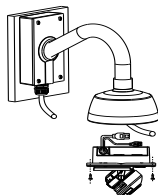
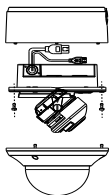

Remark: Appearance of Installation steps is for reference only