

DS-1273ZJ-160B

Wall Mounting Bracket for Dome Camera
(With junction box)

Features:

- Aluminum alloy material with surface spray treatment
- Design with cable entry hole
- Better water proof design
- Convenient installation coordinating with cap

Dimension:

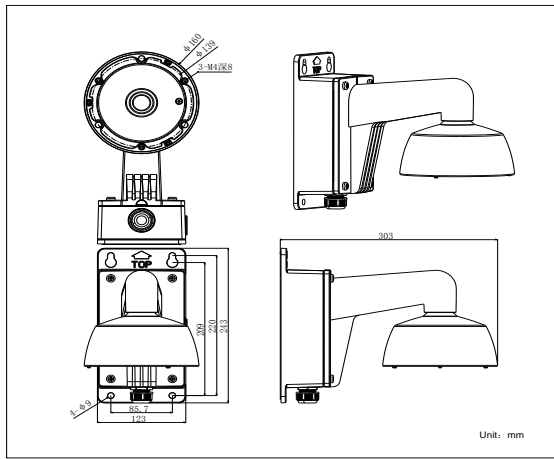

Order Model:

DS-1273ZJ-160B



Parameter:

Model	DS-1273ZJ-160B
Parameters	Wall Mounting Bracket for Dome Camera(with junction box)
Appearance	Hikvision White
Range of Application	Suitable for dome camera wall mounting
Material	Aluminum Alloy
Dimension	Φ 160×243×303mm
Weight	1630g

Notice:

- The bracket is for dome camera
- Pay attention to color matching
- The bracket should be installed on flat wall
- The wall must be capable of supporting over 3 times as much as the total weight of the camera and the mount.
- The maximum load capacity of the bracket is 4.5KG

Model Suitable:

DS-2CD72XXF-E(I)Z(H)(S), DS-2CD72X3PF-E(I)Z(H)(S), DS-2CD72X3NF-E(I)Z(H)(S), DS-2CD7293PFW-D-E(I)Z(H)(S), DS-2CD7293NFW-D-E(I)Z(H)(S), DS-2CD72X4FWD-E(I)Z(H)(S), DS-2CD4312F(WD)-(I)Z(H)(S), DS-2CD4324F-(I)Z(H)(S), DS-2CD4332FWD-(I)Z(H)(S)

Installation Step:

- ① Choose the appropriate wall to fix the junction box

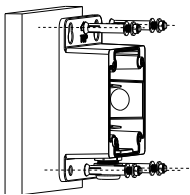

- ② Wiring through waterproof stopper

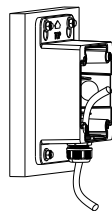

- ③ Install bracket to junction box; wiring and screw up

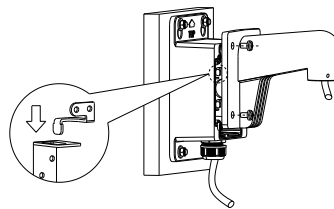

- ④ Fix cap to bracket and fix with fastening screw; wiring

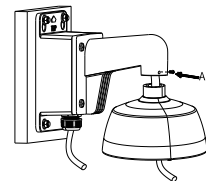

A: Fastening screw

- ⑤ Take off the lower dome and inner module

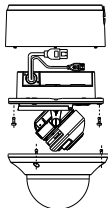

- ⑥ Complete wiring and fix inner module to cap

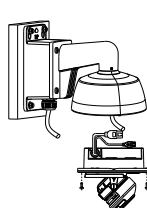

- ⑦ Adjust the view angle; install lower dome and screw up

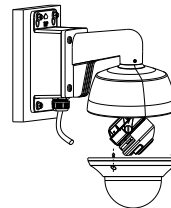

- ⑧ Installation Complete

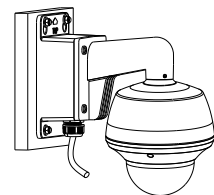

Note: The actual bracket may vary from the picture above.