



DS-2101ZJ

Electrical Control Wall Mounting Bracket

Key Features:

- Composite fiber body, steel plate base and spray-painted surface
- Self-contained power interface for both camera and bracket
- Pan-Tilt control by RS485

Dimensions:

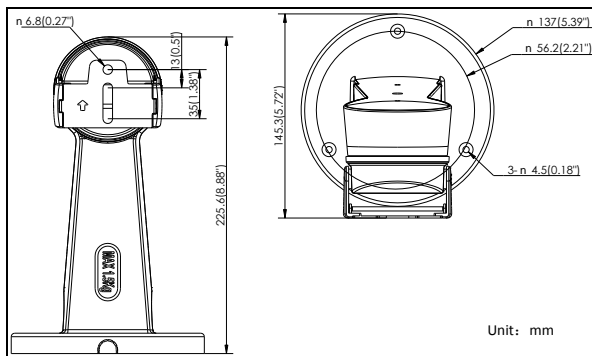

Specification:

Model	DS-2101ZJ
Parameter	Wall Mounting Bracket
Appearance	Hikvision white
RS485	Support Pelco-D, Baud rate 9600bps, Address bit 0
Application	Suitable for box camera, bullet camera and zoom camera
Material	Composite fiber and Steel plate
Adjustment Angle	Horizontal: 0° ~180°, Vertical: -45° ~15°
Dimension	220mm×80mm×90mm
Rotational Speed	MAX 20°/S
Weight	400g
Power Consumption	MAX 4W(Rotational), 0.3W(Motionless)
Power Supply	DC12V/2A
Operating Condition	-30°C~60°C

Notes:

- The bracket should be installed on flat wall.
- Diameter of the installation hole site should be within 6.5 mm
- The wall must be capable of supporting over 3 times as much as the total weight of the camera and the bracket.
- The maximum load capacity of the bracket is 1KG

Ordering Model:

DS-2101ZJ

Installation Step:

① Choose the proper template

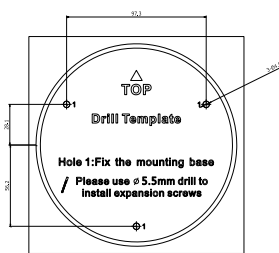

② Loosen the screws, disassemble the base

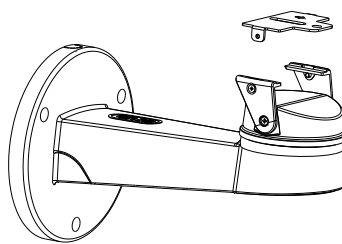

③ Fix the body to the wall and screw up

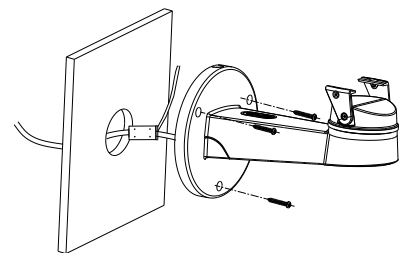

④ Fix the camera to the base

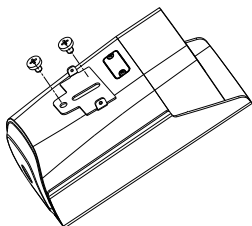

⑤ Install the base to the body

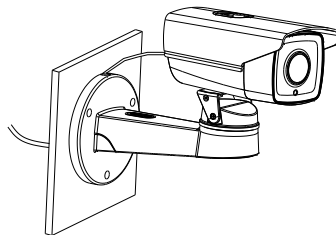

⑥ Connect the wire according the picture below

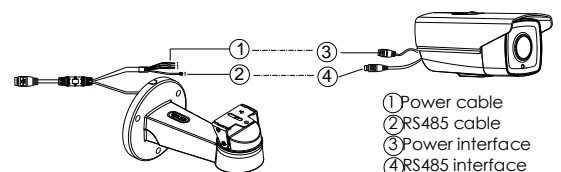

Note: The actual box camera may vary from the picture above.